



IP68



CALIBER 52 SUB

Caliber 52 sub is an extremely efficient compact underwater recessed LED projector, designed for optical excellence and engineered for complete resilience. Caliber 52 sub offers a choice of four colour temperatures as standard (2200K, 2700K, 3000K and 4000K) and delivers 90 CRI for excellent colour rendering, and with binning-free LEDs carefully selected from two-step MacAdam's ellipses, colour consistency is assured throughout the unonovesette portfolio. With a deep recess of the in-house designed PCB, Caliber 52 sub offers excellent glare control.

Caliber 52 sub è un apparecchio a LED dalle dimensioni compatte da immersione estremamente efficiente. Ideato con un'ottica eccellente e progettato per una completa flessibilità. Caliber 52 sub offre una scelta fra quattro temperature di colore standard (2200K, 2700K, 3000K e 4000K) tutte con CRI maggiore di 90 per una eccellente resa cromatica. Binning-free e due-step MacAdam's ellipses LED, assicurano consistenza del colore in tutte le versioni previste da unonovesette. Con l'elettronica progettata internamente e ben posizionata, Caliber 52 sub offre un eccellente controllo dell'abbagliamento.

TECHNICAL DATA / DATI TECNICI:

 IP68

 2W

 140 lm (3000K)

 >90



 2200K / 2700K / 3000K / 4000K

 10° / 23° / 43° / 10°x40°

 Smart Shield

FINISHES / FINITURE:

 Stainless steel electropolished AISI316L
Acciaio INOX elettrolucidato AISI316L

OPTICS / OTTICHE:

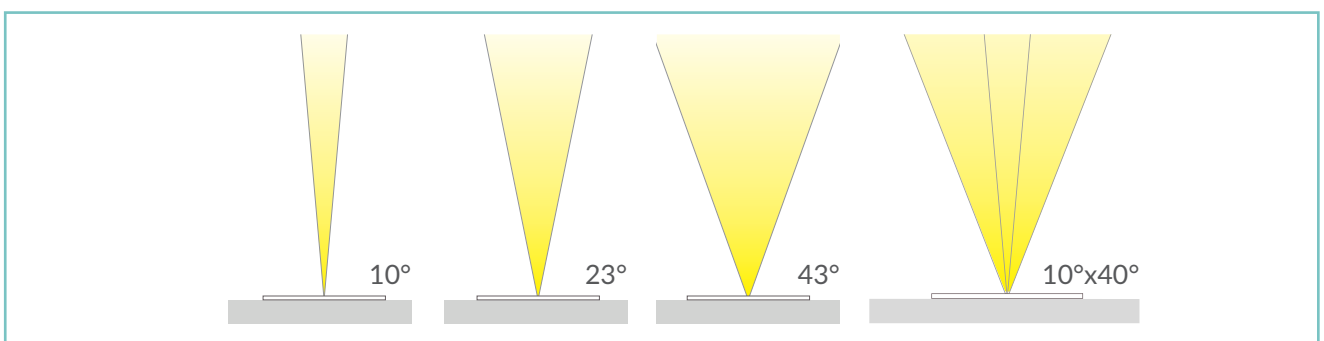

unonovasette

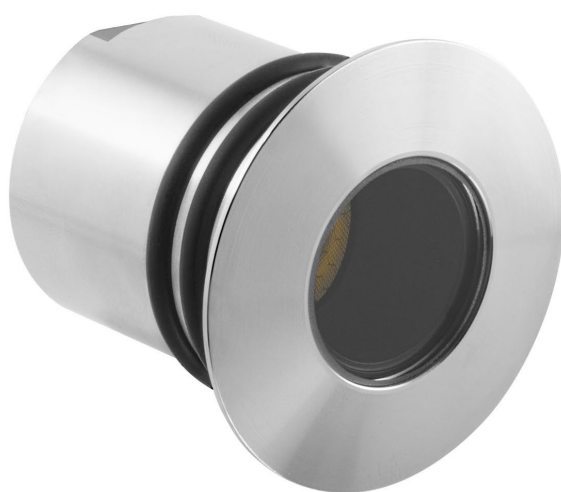
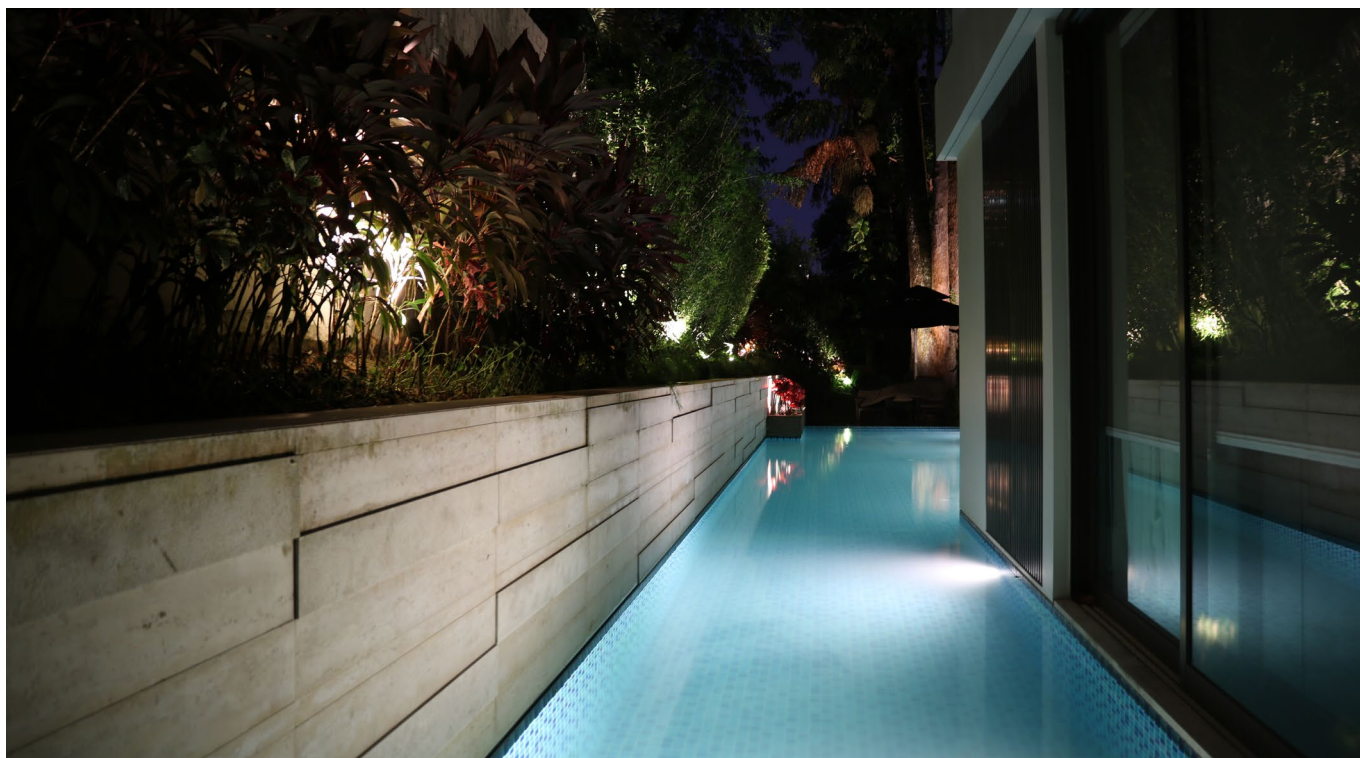

unonovasette

PRODUCT CODE / CODICE PRODOTTO:

C52 = CALIBER 52 SUB 	Select one component from each column to specify a complete configuration: Selezionare un componente per ogni colonna per la configurazione completa:			
	LED colour / Colore LED	Optics / Ottiche	Finish / Finiture	Power / Potenza
22 = 2200K 27 = 2700K 30 = 3000K 40 = 4000K	N = 10° M = 23° W = 43° E = 10°x40°	12 = Stainless steel electropolished AISI316L / Acciaio INOX elettrolucidato AISI316L	02 = 2W	

Standard configuration example/
Esempio di configurazione standard:

C52.30.N.12.02 Caliber 52 SUB 3000K 10° optics stainless steel / Acciaio INOX 2W

POWER SUPPLIES 24Vdc CONSTANT VOLTAGE / ALIMENTATORE TENSIONE COSTANTE 24Vdc:





On / Off

Code / Codice	Input	I Out	V Out	Watt	IP	#Caliber 52 sub
PSU.CX.004	110+240V / 50/60 Hz	0,9 A	24Vdc	20	IP20	Max 8
PSU.CV.005	90+305V / 47/63 Hz	1 A	24Vdc	25	IP67	Max 9
PSU.CV.006	90+305V / 47/63 Hz	2,5 A	24Vdc	60	IP67	Max 25
PSU.CV.007	90+305V / 47/63 Hz	3,75 A	24Vdc	90	IP67	Max 36
PSU.CV.021	90+305V / 47/63 Hz	10 A	24Vdc	240	IP67	Max 80

Control gear / Elettronica di controllo

Code / Codice	Input	I Out	V Out	Watt	IP	#Caliber 52 sub
CGE.004 - 0/1-10V	24Vdc	6,5 A	24Vdc	156	IP20	Max 70
CGE.017 - DALI	24Vdc	6,5 A	24Vdc	156	IP20	Max 70
CGE.017.IP - DALI	24Vdc	6,5 A	24Vdc	156	IP67	Max 70
CGE.020 - DMX	24Vdc	6,5 A	24Vdc	156	IP20	Max 70

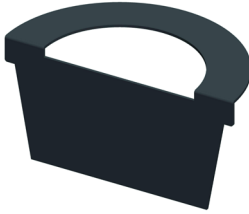
ACCESSORIES / ACCESSORI

 Housing box Cassaforma HB.002 (70g)	 Honeycomb louver Schermo alveolare ACC.084	 Anti-Glare louver Frangiluce ACC.008	 Cable Cavo 10m 15m 20m 25m
 Housing box IP Cassaforma IP HB.013 (320g)			

CALIBER 52 SUB

TECHNICAL DRAWING / DISEGNO TECNICO:

RECESSED HOLE / FORO INCASSO:

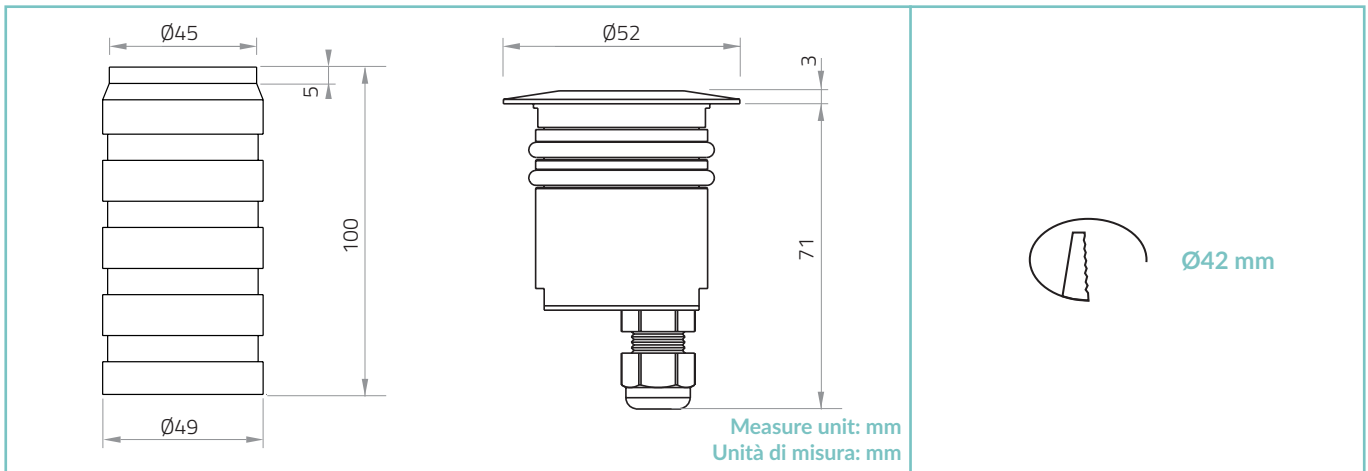

TECHNICAL SHEET / SCHEDA PRODOTTO:

Body: Machined and electropolished stainless steel AISI316L
Glass: Extra clear 4mm tempered glass
Finishes: Electropolished stainless steel AISI316L
Installation: Housing box
Power supply cables: 500cm NS20N PCP 2x0,5mm²
Power supply: Constant voltage 24Vdc
Power consumption: 2 Watt
CRI: >90
Bin selection: Binning free 2 step MacAdam's
Lumen output (source): 140 lm (3000K)
Lumen output (delivered): 113 lm (3000K)
Operating temperature: -20°C +50°C
IP rating: IP68 (5 meters underwater)
Insulation class: Class III
Impact resistance: IK08
Weight: 600g
Optics: 10° / 23° / 43° / 10°X40°
LED colour temperature: 2200K / 2700K / 3000K / 4000K
Lifetime LED: 50000h L95 B10 (Ta 25°C)
Photo biological risk: RG0 / RG1

Corpo: Acciaio INOX AISI316L elettrolucidato
Vetro: Vetro temprato extra chiaro 4mm
Finiture: Acciaio INOX AISI316L elettrolucidato
Fissaggio: Cassaforma
Cavo di alimentazione: 500cm NS20N PCP 2x0,5mm²
Alimentazione: Tensione costante 24Vdc
Potenza assorbita: 2 Watt
CRI: >90
Selezione bin: Binning free 2 step MacAdam's
Flusso sorgente: 140 lm (3000K)
Flusso apparecchio: 113 lm (3000K)
Temperatura di funzionamento: -20°C +50°C
Grado di protezione: IP68 (5 metri in immersione)
Classe d'isolamento: Classe III
Protezione impatto: IK08
Peso: 600g
Ottiche: 10° / 23° / 43° / 10°X40°
Temperatura colore LED: 2200K / 2700K / 3000K / 4000K
Vita media LED: 50000h L95 B10 (Ta 25°C)
Rischio fotobiologico: RG0 / RG1

PHOTOMETRICS / CURVE FOTOMETRICHE:

10° - 2 Watt

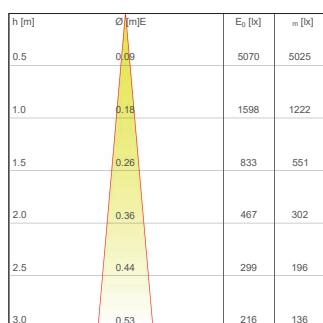

— C0 - C180 (10,0°)

23° - 2 Watt

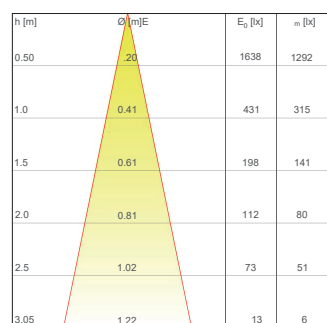

— C0 - C180 (23,0°)

43° - 2 Watt

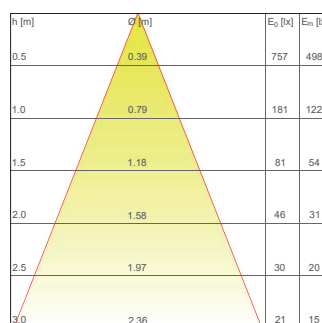

— C0 - C180 (43,0°)

10°x40° - 2 Watt

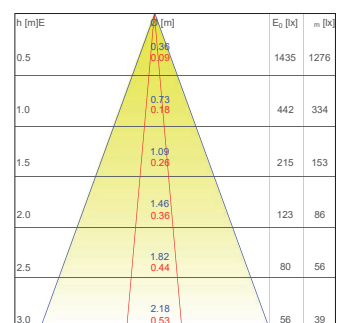

— C0 - C180 (10,0°) — C90 - C270 (40,0°)